

Betontherm *Styr* XPS

Reinforced insulation composite system with cement bonded particle board and extruded polystyrene

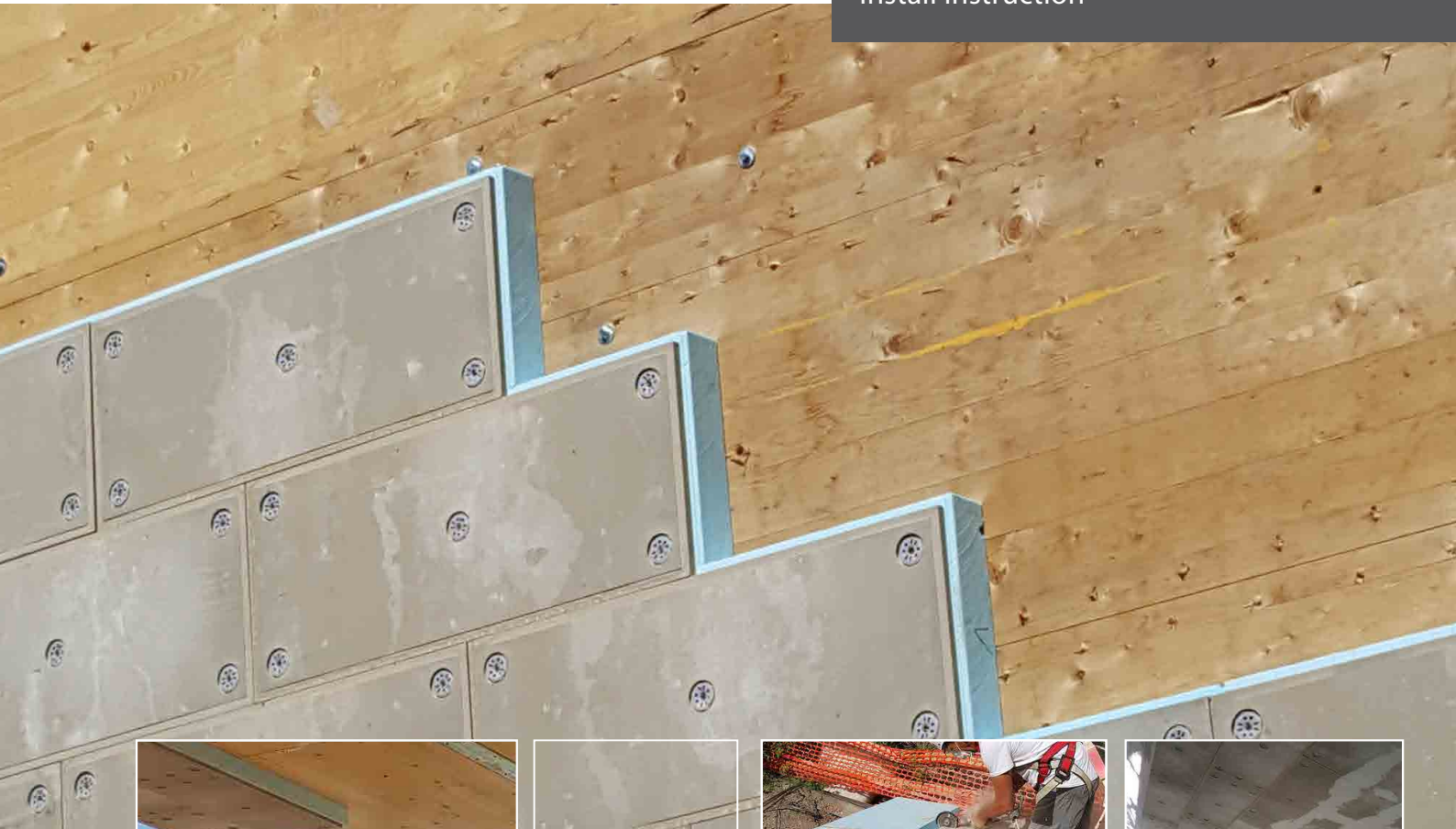

Install instruction



DESCRIPTION

Betontherm *styr* XPS is a modular reinforced insulating composite system with high thermo-acoustic insulation strength, an excellent mechanical strength and high thermal displacement, suitable for particular humid environments.

High insulating composite system, both internal and external, which protects perimeter walls, ceilings, attics. Suitable both for traditional constructions and for dry systems in X-Lam or Platform frame type wood.

Betontherm *styr* XPS is an ecologic insulation composite system in high density cement bonded particle board (1350 Kg/m³) BetonWood and extruded polystyrene XPS type.

The system includes:

- the panels Betontherm *styr* XPS are realized by two coupled panels: one is made by cement bonded particle board BetonWood, the layer with high mechanical strength and high density, and the other is made by extruded polystyrene XPS type which guarantees the thermo-acoustic insulation;
- Betonfix dowel equipped with an anti-thermal bridge protection cap;
- glass fiber reinforcement net Betonnet and accessories;
- suitable skim products.

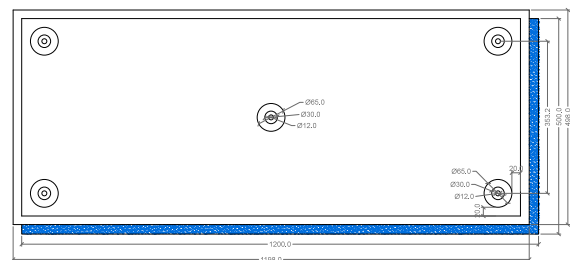
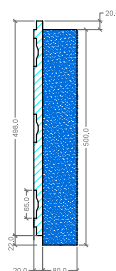
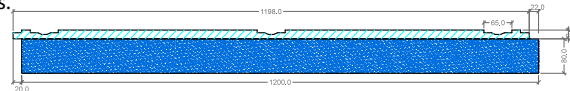

If you need more informations about the uses and the installation, our staff are ready to answer your questions on www.betontherm.com



| THE SYSTEM

The reinforced thermal composite system **Betontherm styx XPS** is a modular system studied to give a simple, smart and functional solution for the realization of a thermal composite system (ETICS) suitable for public locations and buildings like hospitals, schools, libraries, prisons, even fire protection systems. It can be installed quickly and without specialized technicians and workers.

| FIRE REACTION

The thermal insulation composite systems **Betontherm fiber, cork and styx** thanks to the external cement bonded particle board with a fire class A2 are suitable for fire escape ways, schools, hospitals, public buildings in which there are insulation and safety needs.

| MECHANICAL STRENGTH

The thermal insulation composite systems **Betontherm fiber, cork and styx** having a cement bonded particle boards with a thickness from 16 to 20 mm, offers a high mechanical resistance, not only for hanging accessories on the surface but also for resisting vandalism.

| PHASES

The install of **Betontherm styx XPS** reinforced insulation composite system must be executed the following phases:

- control and preparation of the substrate
- panel positioning
- fixing system with dowels
- reinforced skim layer
- finishing

| PHASE 1 - CONTROL AND PREPARATION OF THE SUBSTRATE

Wood substrates

Immediately before mounting the panels, the substrate must be carefully examined. It must be leveled / free, cleaned, dried (wood moisture $\leq 20\%$) and sufficiently wide for fixing.

For timber frame constructions, the maximum allowable compartment spacing size must be verified.

Mineral substrates

The substrate must be dry, free of dust and separating substances.

In particular, in masonry work, the interior plastering work must be completed before installing the thermal insulation composite system, so that the external walls are not exposed to an increase in humidity. Especially in new buildings, it is important to ensure continuous protection against rain before installing a thermal insulation system. The penetration of moisture into the mineral substrate is not permitted.

In particular, when renovating old buildings it is important to exclude the presence of rising damp. The layers of plaster not well fixed must be removed, the defects must be leveled.

Differences in height up to approx. 10 mm can be compensated with our mineral binders and reinforcing mortars. For greater differences in level, a leveling agent must be applied, which must be completely dried before placing the panels. Alternatively, the installation of an additional wooden structure can be provided.

| PHASE 2 - PANEL POSITIONING

Lay the first layer of the panels, arranged horizontally along the largest length, resting them from the bottom upwards starting from the base of the wall.

It is also possible to realize the skirting of the insulating composite system, placing a first band on the floor using special insulating panels in extruded polystyrene XPS type. In this way the system is impermeable to rising water.

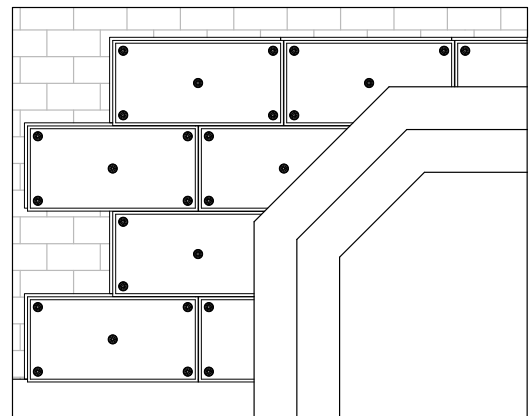



| PHASE 3 - FIXING SYSTEM

The panel positioning of the reinforced insulation composite system **Betontherm styr XPS**, specifically, it must be executed:

- lay the panels with staggered joints starting from the starting profile, without the use of glue, but taking advantage of the stepped profile of **Betontherm styr XPS**;
- lay the **Betontherm styr XPS** panel to wall and with a drill (8 mm point), drill the wall underneath the appropriate pre-milled housing for the **Betonfix** plugs (2 types which we can see on the left);
- clean the plug housing with compressed air before inserting the **Betonfix** "mushroom" head plug for masonry;
- anchor the panel to the wall by inserting the plugs and screwing with the drill the element that comes out from the plugs head (attention: do not use percussion drills on perforated walls).



Betonfix FIF-CS8 - Anchor for fixing **Betontherm** panels on masonry supports



Betonfix 6H-NT - Anchor for fixing **Betontherm** panels on wood supports

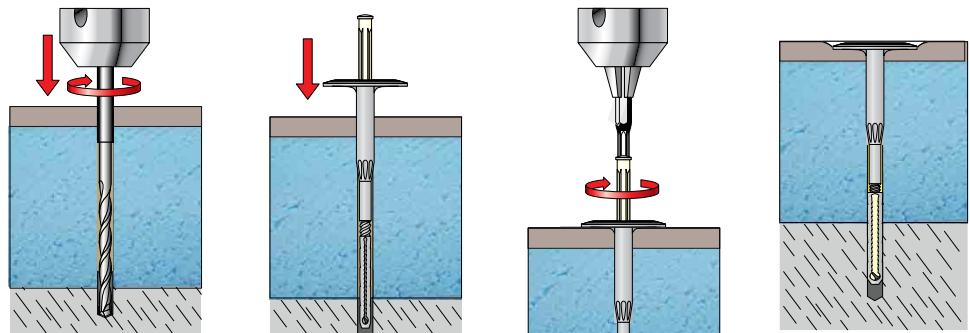

| EXTREMELY EASY INSTALL

The thermal composite systems **Betontherm styr XPS** using for every panel 5 plugs with steel core and with a load capacity of 150 kg each, they allow the panels to be fixed securely to the masonry without gluing or without having to restore the underlying plaster.

- when you install **Betontherm styr XPS** adjacent panels, be careful to make the insulating layer of one panel adhere well with the other, so that the outer edges coincide perfectly;
- for the realization of the corners in reinforced thermal insulation systems **Betontherm styr XPS**, please use special panels with pre-cut insulating layer making sure that the cement bonded particle board always surmounts the insulating layer;

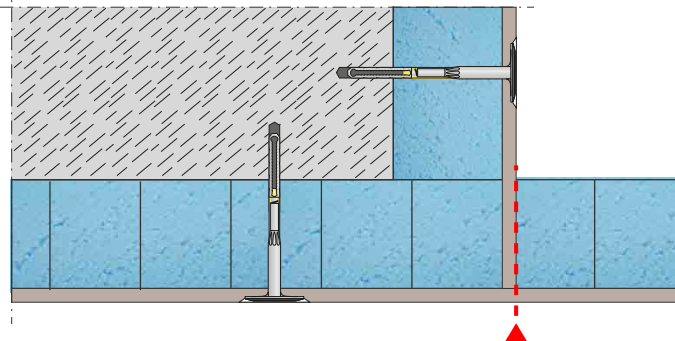

- in case of cutted **Betontherm styr XPS** panels, and so without dowel's housing, a milling cutter will be provided for use to create housings directly on site;



| PHASE 4 - JOINTS ARMORING AND SKIMMING



BetonNet strip - Adhesive glass fiber net strip used as a cover joint near the junctions.

After fixing reinforced thermal insulation composite system **Betontherm styr XPS** panels, we can proceed with joints armoring between one panel and the other covering its pre-milled edges with the adhesive strip **BetonNet strip** (which we can see in the figure on the left). The overlap of the joint cover strip must be at least 10 cm.

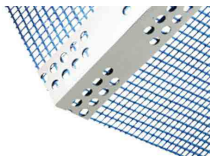

Betoncorner Alu - Angular glass fiber net with a density of 165 g/m² reinforced with al aluminium profile that forms a 90° angle. Used for corners, sharp edges panels.

Once reinforced panel joints, pass to their skimming and grouting of anchors and angular profiles (internal and external) with a two-component polyurethane adhesive recommended by **BetonWood**, **Mapelastick**, a two-component elastic cementitious mortar that must be applied within 60 minutes from mixing.



| PHASE 5 - ACCESSORIES AND ANGULARS INSTALL

We recommend to pay the maximum attention to the joining between **Betontherm styr XPS** reinforced thermal insulation panels and the components on the façade (doors, windows, door frames, expansion joints of the building, corners, etc.) and use accessories and angles suitable for laying this type of system in order to complete the execution in a workmanlike manner:

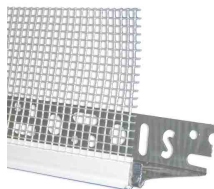

Betondrip starter PVC - Drip edge with glass fiber net with a density of 165g/m². Sealing connection between the system's starting base and the reinforced skimming layer.

- cover the corners with **Betoncorner Alu**;
- cover the window and door edges with the preformed accessory **Betoncorner Alu**;
- for the starter base to install the first thermal insulation system panels it is recommend to use **Betondrip starter PVC** which we can see in the figure on the left;
- the system doesn't need of thermal expansion joints, but if they are present in the building, these must be respected.

| PHASE 6 - NET AND SKIM PRODUCT INSTALL

Before execute the armored skimming with glass fiber net 360 gr/m² **BetonNet glass 360**, prepare the support:



BetonNet glass 360 - The glass fiber net with a density of 360 g/m² for external/internal reinforced insulation composite system (suitable for all **Beton-Therm** products). 50 m² rolls.

- check the surface flatness and if necessary intervene with an orbital sander;
- moisten and clean the **Betontherm styr XPS** insulating panels with a damp cloth on the cement side to eliminate surface dust.



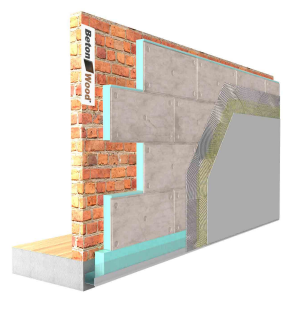

Beton AR1 - Monocomponent cementitious mortar for bonding and skimming thermal insulation panels for Betontherm reinforced thermal insulation composite system

| PHASE 7 - SKIMMING LAYER

After fixing panels, spread on them the monocomponent cementitious mortar Beton AR1 type with an uniform thickness and incorporate the glass fiber net 360 gr/m² BetonNet glass 360 . BetonNet glass 360, alkali resistant, it must be unrolled from top to bottom and flattened with a smooth trowel on the fresh layer of cementitious mortar and it must be overlapped on the joints by at least 10 cm.

In this way a compact and regular surface is obtained to receive the finishing covering, which must be applied only when the skimming layer is well hardened and cured.

The monocomponent cementitious mortar Beton AR1 type can be applied vertically without dripping and without letting the insulating panels slip, even if large:

- consumption 1,3-1,5 kg/m² per mm of thickness;
- temperature of use +5°C ÷ +40°C;
- do not apply in the presence of direct irradiation in the central hours of the day or in the event of strong wind or heavy rain;
- do not apply on wet surfaces, or frost, in the thawing phase or with risk of freezing in the next 24 hours of application.

| PHASE 8 - SECOND HAND

Apply the second hand of skim coat according to the indications of STEP 7. It is advisable not to exceed the thickness of 2 mm for the layer of skimming agent.

| PHASE 9 - FINISHING LAYER

External whitening to be carried out with "Silancolor Tonachino" coating once the reinforced skimming has set, the hardening time varies from 1 to 3 days and depends on the climatic conditions.

The protection cycle involves the application of a "Silancolor Tonachino" covering layer. If you want to obtain a more homogeneous application effect, you can apply a first layer and, after 24 hours, the second hand of product, taking care to distribute a uniform layer of material and then working with a plastic trowel eventually wet for homogenize the aesthetic effect or by intervening with a dampened sponge trowel according to the desired aesthetic effect.

Head office:
Via Falcone e Borsellino, 58
I-50013 Campi Bisenzio (FI)

T: +39 055 8953144
F: +39 055 4640609

info@betonwood.com
www.betonwood.com

BTHSTX-ISTPM R.18.03

This document replaces and cancels previous versions. Only complete BetonWood systems must always be applied. Mixed systems with components from other unauthorized brands are not allowed.

The indications and prescriptions indicated, are based on our current technical-scientific knowledge, which in any case are to be considered purely indicative, as the conditions of use are not controllable by us. Therefore, the purchaser must in any case verify the suitability of the product to the specific case, assuming all responsibility deriving from use, relieving BetonWood srl from any design error, product choice and installation.

For any additional information on the use of this product. contact our technical department. Consult before any purchase terms of sale on www.betonwood.com